

EMCO Win 3D-View Turning

Software Description 3D-Graphic Simulation

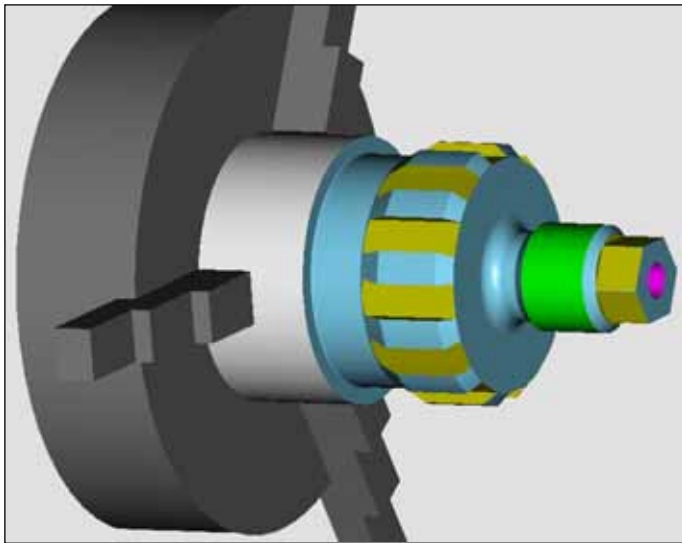

Software Description

EMCO Win 3D-View Turning

Ref.-Nr. EN 1827 Edition C2007-02

This manual is electronically available (.pdf) upon request at any time on the EMCO homepage.

EMCO Maier Ges.m.b.H.
P.O. Box 131
A-5400 Hallein-Taxach/Austria
Phone ++43-(0)62 45-891-0
Fax ++43-(0)62 45-869 65
Internet: www.emco.at
E-Mail: service@emco.at

emco
industrial training systems

Preface

The EMCO Win 3D-View turning software is an accessory to the software products EMCO WinNC for the following control:

- FAGOR 8055 TC TURN
- FANUC 0-TC
- FANUC 21 TB
- SINUMERIK 810/820 T
- SINUMERIK 810D/840D TURN

EMCO Win 3D-View enables to simulate CNC programs three-dimensionally on the screen. The workpieces are rotatable in every position desired at any time. Different types of presentation make it easy to understand even complex turning and milling operations.

The section view, alternatively full, 3/4, 1/2 or 1/4 cut, allows to observe normally hidden sequences.

A collision detection can be carried out additionally (collisions of clamping device and tool holder).

The simulation of tools is rendered possible by an extensive tool library containing all EMCO standard tools. By means of workpiece modelling you can create and implement further individual tools.

In case of inquiries or suggestions for improvement with regard to this instruction manual, please directly contact:

EMCO MAIER Gesellschaft m. b. H.
Department for technical documentation
A-5400 Hallein, Austria

Contents

Installation of Win 3D-View	5
Call-up of Win 3D-View	7
Call-up in WinNC FAGOR 8055 TC	7
Call-up in WinNC FANUC 0-TC	8
Call-up in WinNC FANUC 21 TB	9
Call-up in WinNC SINUMERIK 810/820 T	10
Call-up in WinNC SINUMERIK 810D/840D	11
Basic Settings	12
Input of the Basic Settings for FAGOR 8055 TC	12
Input of the Basic Settings for FANUC 0-TC, FANUC 21 TB and SINUMERIK 810/820 T	14
Input of the Basic Settings for SINUMERIK 810D/840D	16
Setup Toolholder	18
Input for Win 3D-View with FAGOR 8055 TC	18
Input for Win 3D-View with FANUC 0-TC, FANUC 21 TB and SINUMERIK 810/820 T	19
Input for Win 3D-View with SINUMERIK 810D/840D	20
Define Workpiece	21
Define blank workpiece for FAGOR 8055 TC	21
Define blank workpiece for FANUC 0-TC, FANUC 21 TB and SINUMERIK 810/820 T	22
Define blank workpiece for SINUMERIK 810D/840D	23
Examples for Workpiece Definition	24
Simulation	25
Simulation sequence for Win 3D-View with FAGOR 8055 TC	25
Simulation sequence for Win 3D-View with FANUC 0-TC, FANUC 21 TB and SINUMERIK 810/820 T	26
Simulation sequence for Win 3D-View with SINUMERIK 810D/ 840D	28
Tool modelling with the 3D-Tool Generator ..	29
Generating a new tool	30
Copying a tool	30
Changing an existing tool	31
Selecting a tool colour	31
Visualizing a tool	31
Sorting function	32

Installation of Win 3D-View

System requirements

To ensure proper run of Win 3D-View the following minimum requirements must be fulfilled:

- PC Celeron oder Pentium III
433MHz IBM-compatible, 800MHz recommended
- 64 MB RAM, 128 MB RAM recommended
- At least 8MB VGA colour graphics card
- CD-ROM drive
- MF2 keyboard
- 5 MB free hard disk memory
- WINDOWS 95/98/ME/2000 service pack2/XP
- Installation of one of the following WinNC control types

Note:

The following software versions - as indicated or higher - are necessary for the installation of the Win 3D-View:

- FAGOR 8055: at least version **1.11**
- FANUC 0: at least version **14.00**
- FANUC 21: at least version **14.00**
- HEIDENHAIN TNC 426: at least version **1.30**
- SINUMERIK 810/820: at least version **14.00**
- SINUMERIK 810D/840D: at least version **16.00**

Variants of Win 3D-View

EMCO Win 3D-View can be installed for the following WinNC control types:

- FAGOR 8055 TURN and MILL
- FANUC 0 TURN and MILL
- FANUC 21 TURN and MILL
- HEIDENHAIN TNC 426 MILL
- SINUMERIK 810/820 TURN and MILL
- SINUMERIK 810D/840D TURN and MILL

The following Win 3D-View licences are available:

- Demo licence:
A demo licence is valid for 30 days from the first application. Optionally, this period can be prolonged up to 90 days altogether. Before expiry of the demo licence you may enter a valid licence key (see licence manager on the next page).
- Programming place:
The programming and operation of the respective CNC-control type is simulated by WinNC on the PC. The graphic presentation is made possible by Win 3D-View.
 - Single licence version:
authorizes to use one product copy.
 - Multiple licence version:
authorizes the simultaneous use of as many product copies as desired.
 - School licence:
The school licence is a temporally limited multiple licence and only available for a choice of products.

Software installation

- Start Windows 95/98/ME/2000/XP.
- Insert the CD ROM into the drive.
- The installation program is started (CDStart.exe).
- You will be guided through the installation by the menu. Just follow the single steps one after the other.

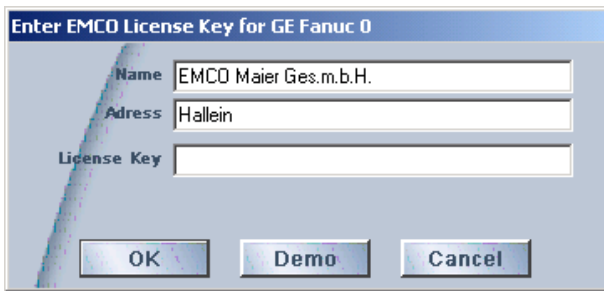

Input window license key enquiry

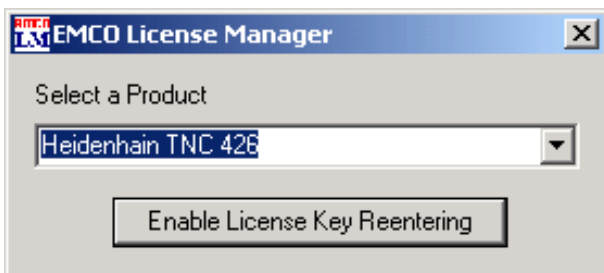

EMCO License Manager

Licence input

After having been successfully installed, an input window appears during initial operation of an EMCO software product and asks for name, address and licence key. This input window appears for every software product installed. In case a demo licence is desired (see page Z1), please select "DEMO". The input window reappears only 5 days before the expiry of the demo licence. A subsequent input of a licence key is also possible via the licence manager (see licence manager below).

License manager

For the release of additional function groups of existing EMCO software products it is necessary to enter a new licence key (exception: demo licence).

The **EMCO License Manager** (see picture on the left) enables the input of further new license keys. For this purpose select the new product in the selection window and confirm the input.

The next time you start your control software an input window appears and asks you to enter name, address and licence key (see picture on the top left).

Please note that the licence key is asked for each software product individually. The picture on the left shows e.g. the input prompt for the licence key for the software product "Heidenhain TNC 426".



Call-up of Win 3D-View

Call-up in WinNC FAGOR 8055 TC

Note:

Please also refer to "Graphic simulation" that is explained in detail in the software description FAGOR 8055 TC, chapter C, operation.





- Press the  key in order to call the directory of the stored workpiece programs.
- Use the cursor to select the workpiece program from the left column and the operating cycle, from which the simulation of the part program shall be started, from the right column (see picture below).
- Press the  key.





Call-up in WinNC FANUC 0-TC

- Select the part program desired.

Calling up the program on the PC:

- Press .
- Enlarge the softkey row by means of .
- Press the "GRAPH" softkey.
- Enlarge the softkey row by means of .
- Press the "3DVIEW" softkey.

Calling up the program by means of the control keyboard:

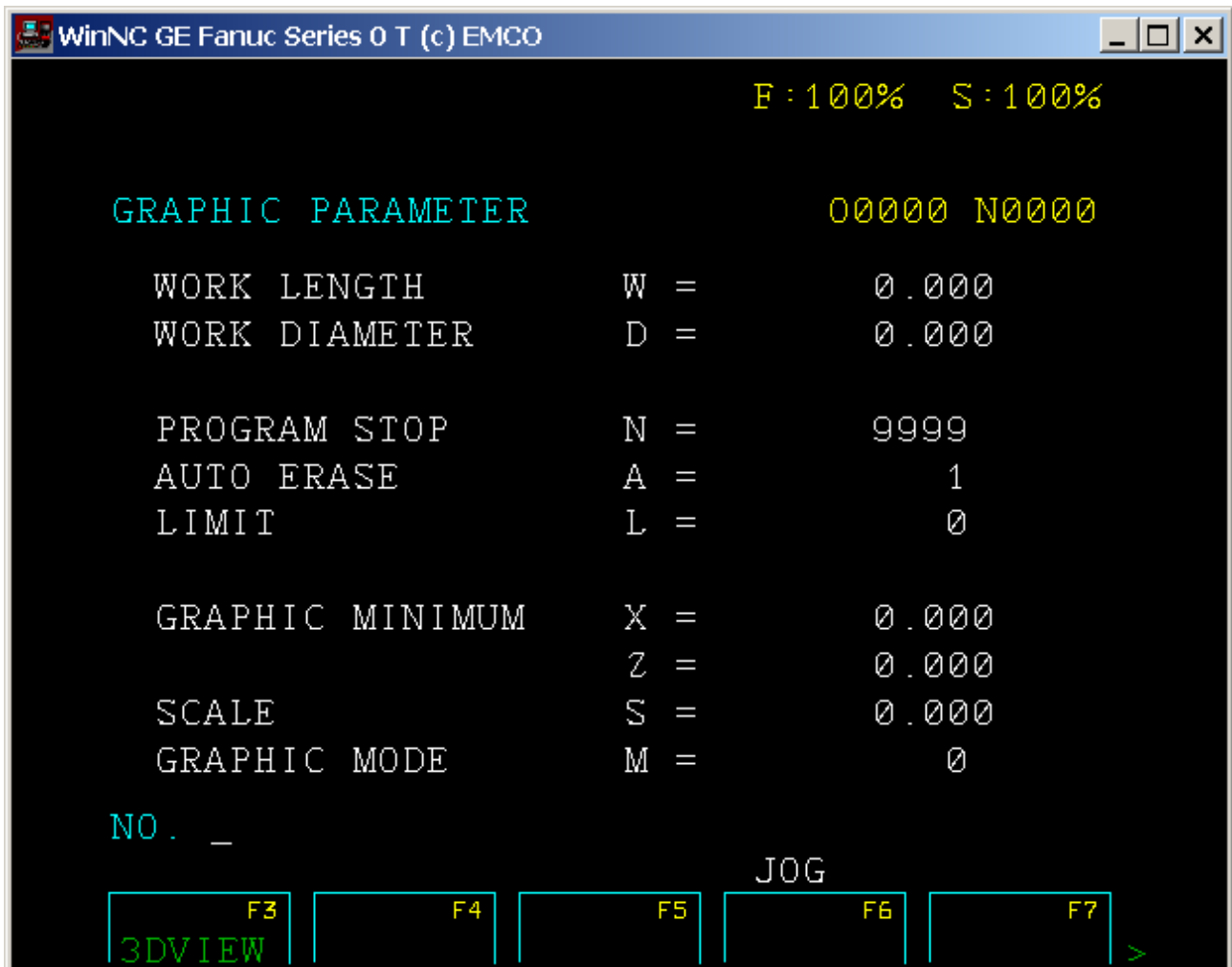

- Press the  key.
- Enlarge the softkey row by pressing .
- Press the "3DVIEW" softkey.





Call-up in WinNC FANUC 21 TB

- Select the part program desired.

Calling up the program on the PC:

- Press .
- Enlarge the softkey row by means of .
- Press the softkey "GRAPH".
- Enlarge the softkey row by means of .
- Press the softkey "3DVIEW".

Calling up the program by means of the control keyboard:

- Press the  key.
- Enlarge the softkey row by pressing .
- Press the "3DVIEW" softkey.

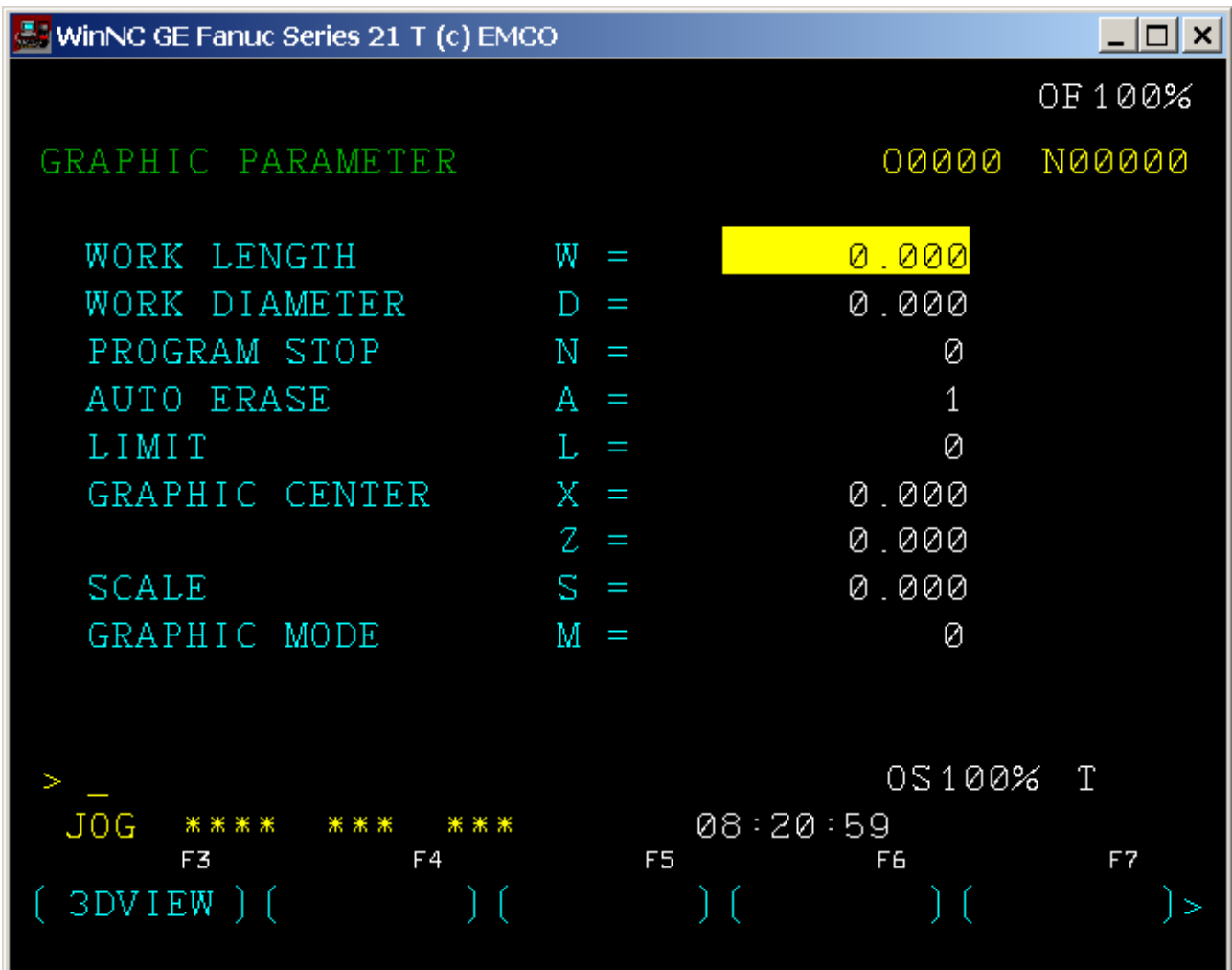

Call-up in WinNC SINUMERIK 810/820 T

- Press the softkey "PART-PROGRAM".
- Press the softkey "EDIT".
- Enter the program number (e.g. %33) and press the softkey "SELECT PROGRAM".
The selected part program is displayed.
- Press the softkey "3DVIEW".

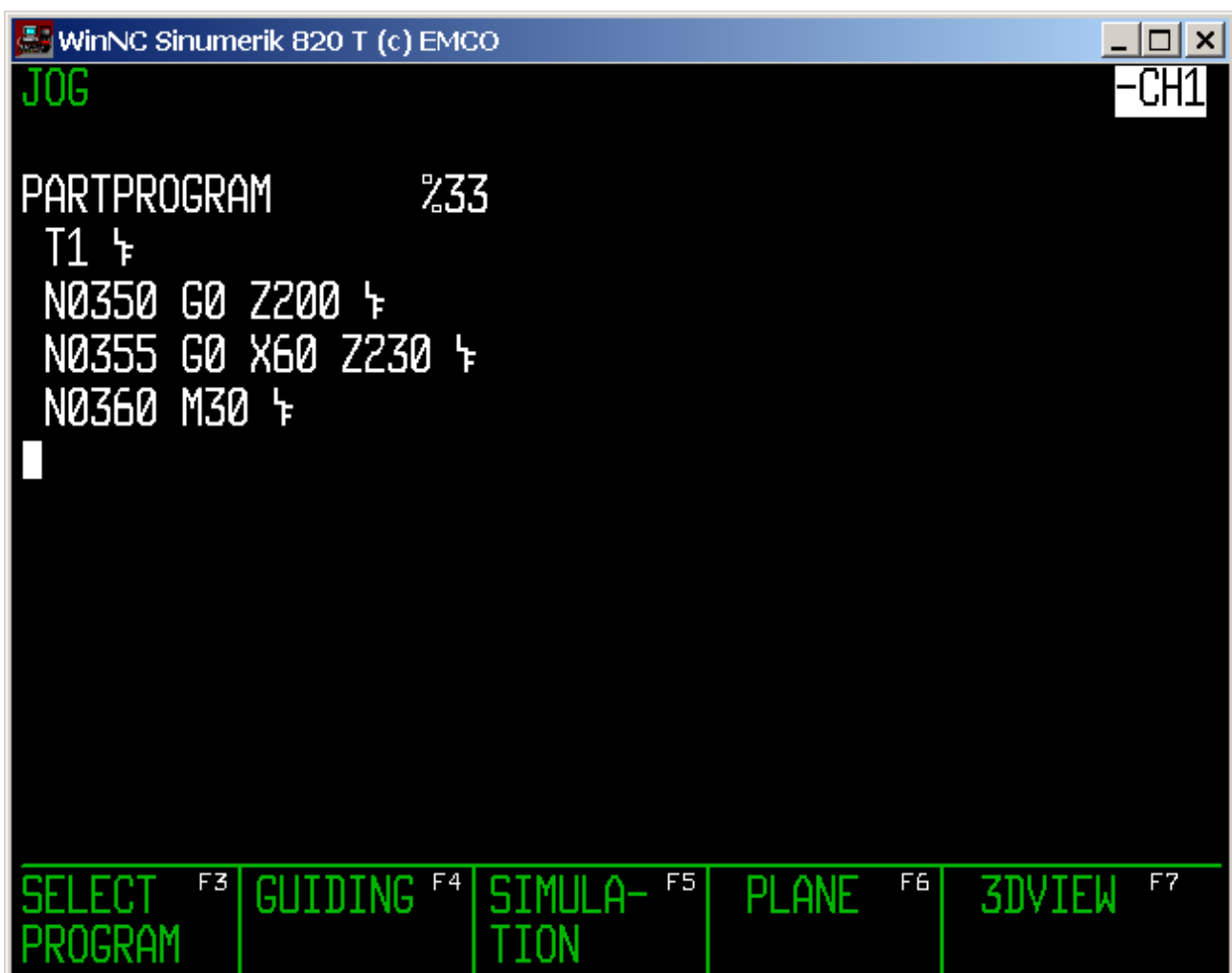

Call-up in WinNC SINUMERIK 810D/840D

- PROGRAM operating mode.
- Select the desired part program.
- Press the softkey "3D-View".

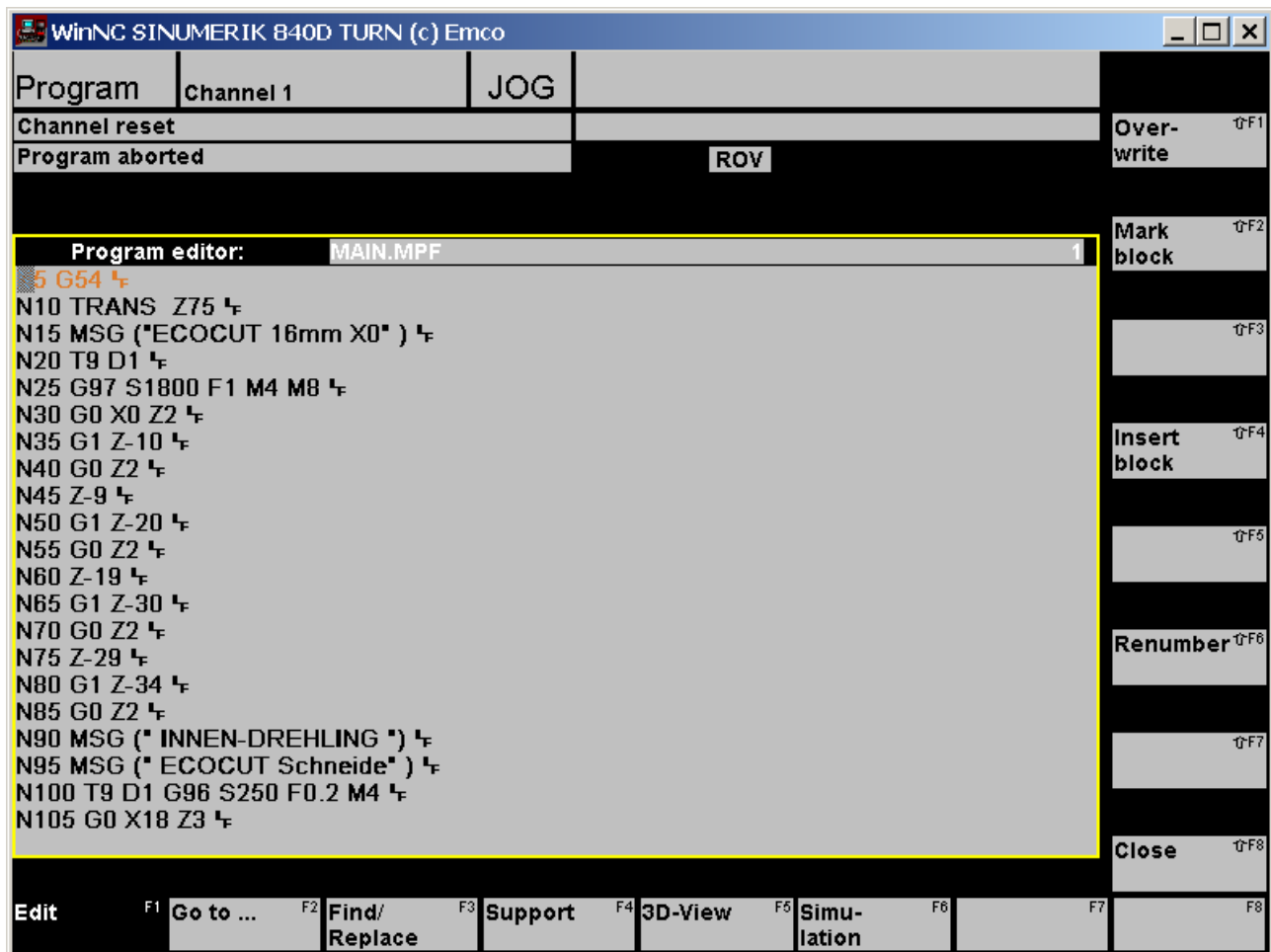

Basic Settings

Input of the Basic Settings for FAGOR 8055 TC

Press the softkey "TYPE OF GRAPHICS" and select the graphics type "X-Z SOLID".

Press  and select "3D-VIEW PARAMETER".

You may define the following settings:

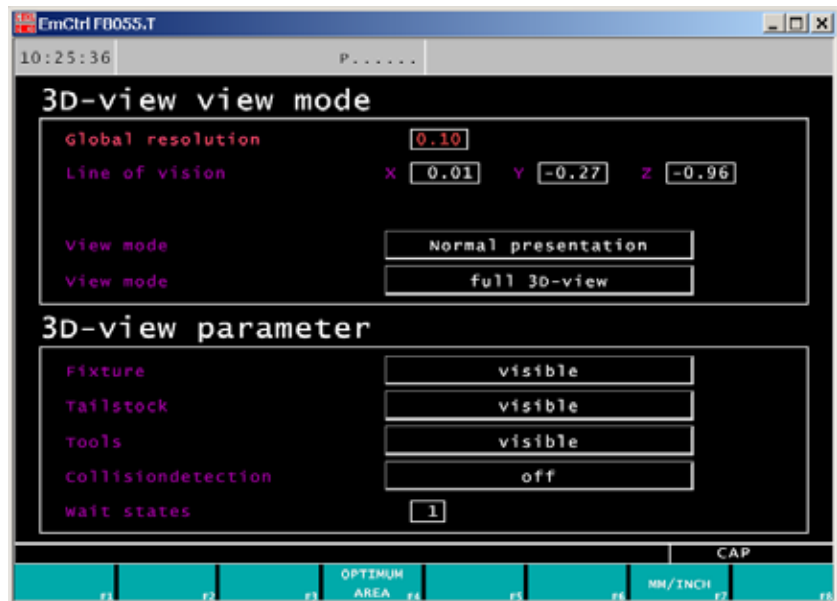

3D-View View mode

Global resolution:

You may select values between 0.01 and 0.3. The higher the resolution, the exacter is the structure of the 3D-picture.

Line of vision:

The "line of vision" enables a presetting of the initial view on the blank workpiece. Of course, the line of vision can always be changed during simulation by means of the mouse.

View mode:

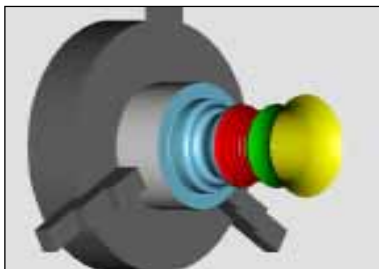

- Normal presentation

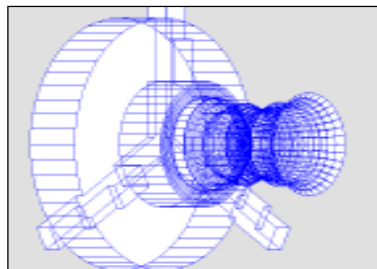

- Wire frame complete

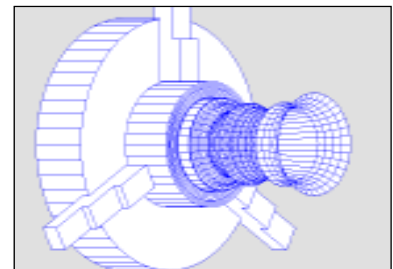

- Wire frame

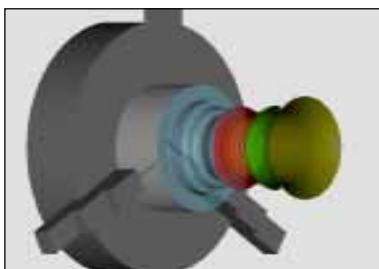

- Transparent raw part



- Shaded 2D profile

View mode:

The section view enables to observe normally hidden sequences. You may choose between the following views:

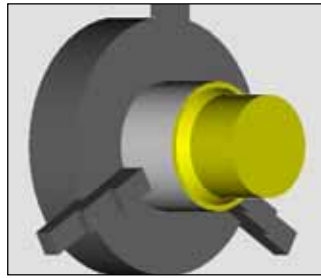
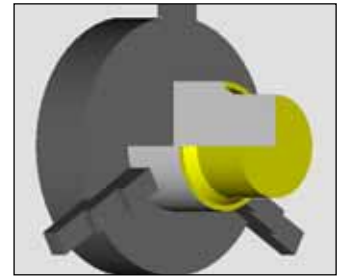
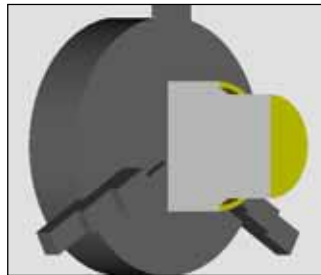
*full 3D-view**3/4 view**1/2 view**1/4 view***3D-View parameter**

- **Fixture**
visible/invisible
- **Tailstock**
visible/invisible
- **Tools**
visible/invisible
- **Collision detection**
on/off
- **Wait states**
0-99

Collision detection

The collision detection supervises the following situations:

- Collisions of tool and clamping device. When the display of the clamping device is switched off, collisions of clamping devices are not monitored.
- Collisions of non-cutting tool parts with the workpiece or the clamping device.

In case of a collision the simulation will be aborted.

Wait states

The simulation can be slowed down by means of waiting cycles. A waiting cycle is the freely definable period that has to go by between two tool movements. The waiting cycle is defined in values between 0 and 99.

The higher the value of the waiting cycle, the longer is the duration of the simulation.

Input of the Basic Settings for FANUC 0-TC, FANUC 21 TB and SINUMERIK 810/820 T



Basic settings for FANUC 0-TC

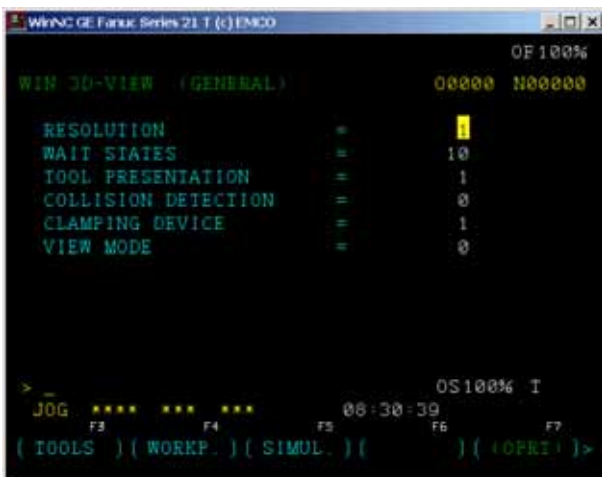

Basic settings for FANUC 21 TB



Basic settings for SINUMERIK 810/820 T

You may define the following settings:

Resolution:

You may choose between three resolution settings:

- 0 low
- 1 medium
- 2 high

Wait states:

The simulation can be slowed down by means of waiting cycles. A waiting cycle is the freely definable period that has to go by between two tool movements. The waiting cycle is defined in values between 0 and 99.

The higher the value of the waiting cycle, the longer is the duration of the simulation.

Tool presentation:

visible 1 / invisible 0

Collision detection:

0 OFF / 1 ON

The collision detection supervises the following situations:

- Collisions of tool and clamping device. When the display of the clamping device is switched off, collisions of clamping devices are not monitored.
- Collisions of non-cutting tool parts with the workpiece or the clamping device.

In case of a collision the simulation will be aborted.

Clamping Device:

- 0 display of clamping device - OFF
- 1 manual clamping device - ON
- 2 manual clamping device with sleeve - ON
- 3 automatic clamping device - ON
- 4 automatic clamping device with sleeve - ON

The approach and departure of the sleeve to and from the workpiece has to be programmed with M-commands.

View mode:

- 0 Normal presentation
- 1 Wire frame complete
- 2 Wire frame
- 3 Transparent raw part
- 4 Shaded 2D profile

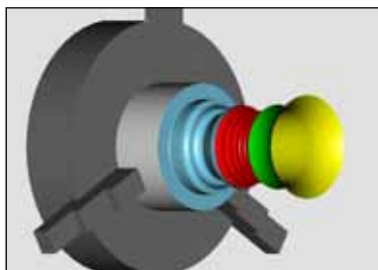

- Normal presentation

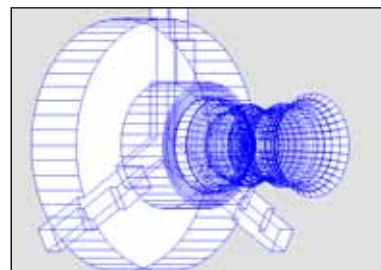

- Wire frame complete

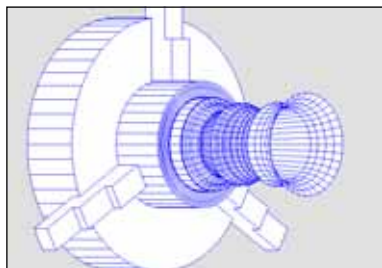

- Wire frame

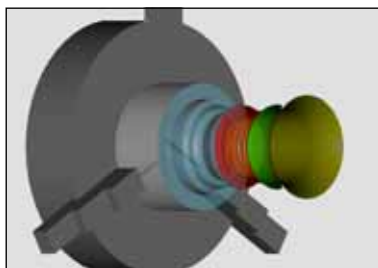

- Transparent raw part



- Shaded 2D profile

Input of the Basic Settings for SINUMERIK 810D/840D

Press the softkey "View".

You may define the following settings:

Global resolution:

You may select values between 0.01 and 0.3. The higher the resolution, the exacter is the structure of the 3D-picture.

Line of vision:

The "Line of vision" enables a presetting of the initial view on the blank workpiece. However, the line of vision can always be changed during simulation by means of the mouse.

By pressing the softkey "standard view dir." the original view appears again.

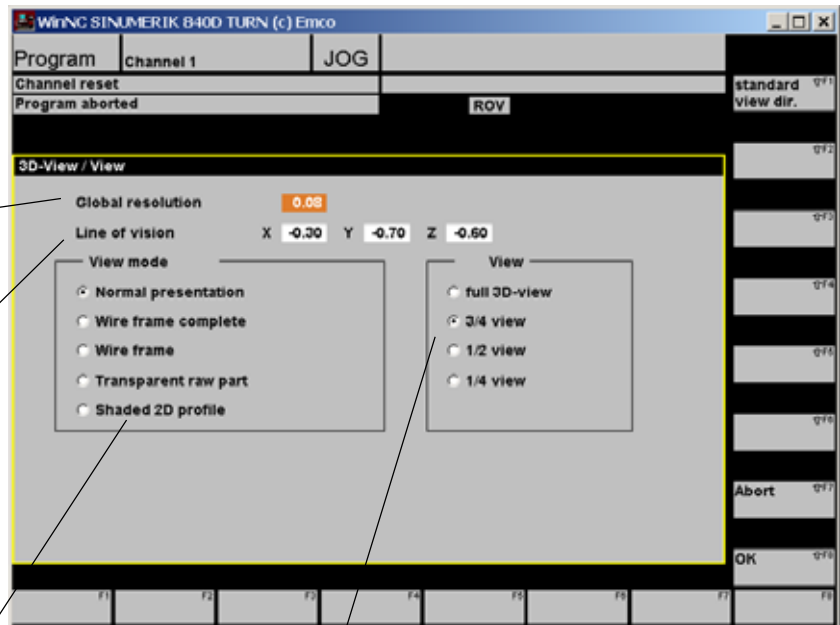

View:
see next page

View mode:

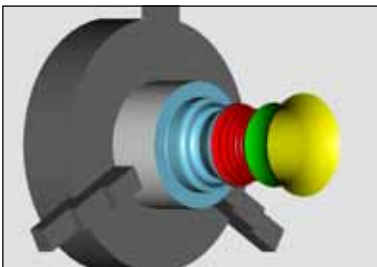

- Normal presentation

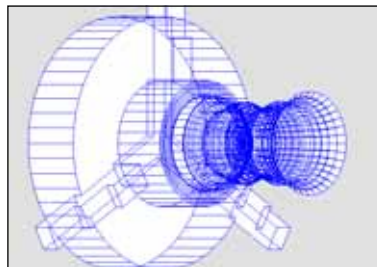

- Wire frame complete

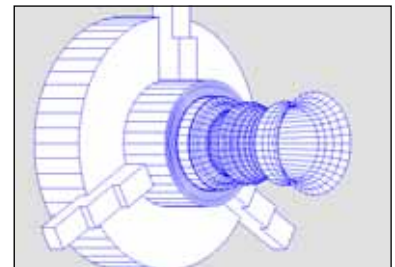

- Wire frame

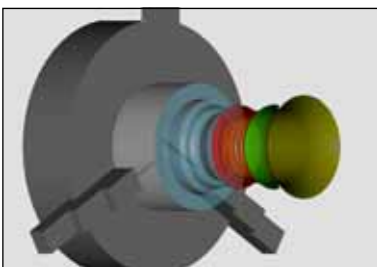

- Transparent raw part



- Shaded 2D profile

View:

The section view enables to observe normally hidden sequences. You may choose between the following views:

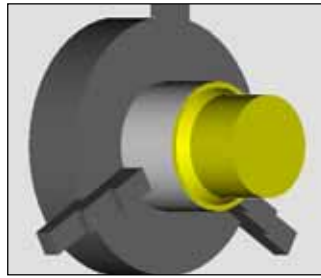

full 3D-view

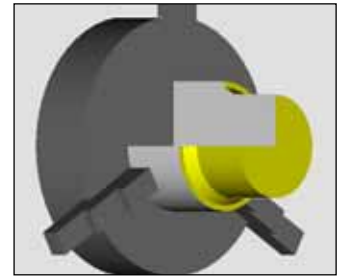

3/4 view

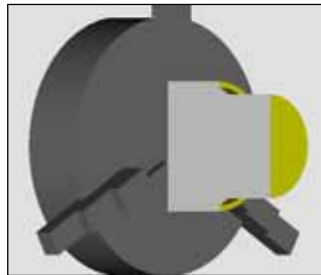

1/2 view



1/4 view

Press the "Parameter" softkey.

The following inputs are possible:

Clamping

- Clamping device visible/invisible
- Tailstock visible/invisible

General

- Collision detection ON/OFF
- The dimensions depend on the machine-coordinate-system or workpiece-coordinate-system.
- Tools visible/invisible
- Wait states 0-99
- Actual channel is intended only for machines with several programming channels.

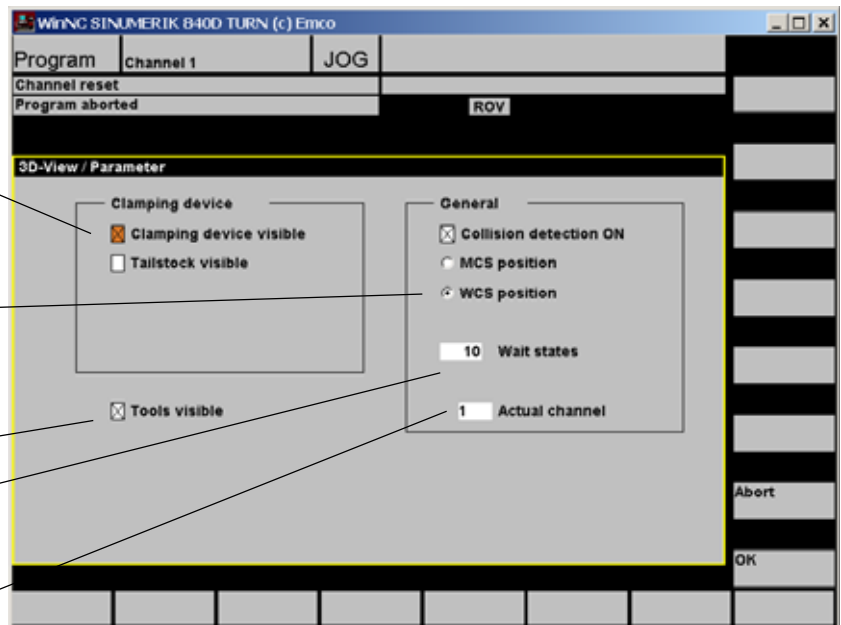

Collision detection

The collision detection supervises the following situations:

- Collisions of tool and clamping device. When the display of the clamping device is not active, collisions of clamping devices are not supervised.
- Collisions of non-cutting tool parts with the workpiece or clamping device.

In case of a collision the type of collision will be displayed and the simulation will be aborted.

Wait states

The simulation can be slowed down by means of waiting cycles. A waiting cycle is the freely definable period that has to go by between two tool movements. The waiting cycle is defined in values between 0 and 99.

The higher the value of the waiting cycle, the longer is the duration of the simulation.

Setup Toolholder

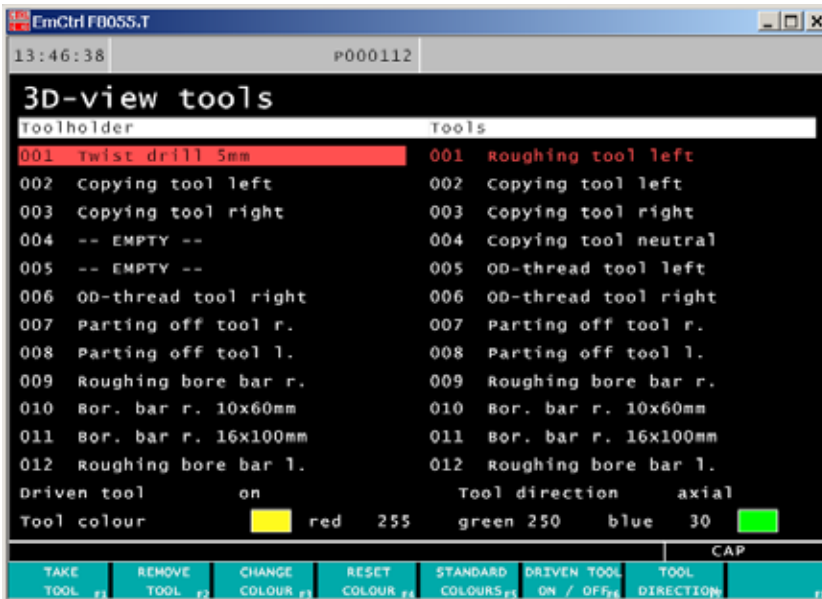

Input for Win 3D-View with FAGOR 8055 TC



Tool selection FAGOR 8055 TC

For the simulation it is necessary that the correct tools are related to the toolholder positions, just as the tools must be clamped in the correct toolholder positions during machining. Win 3D-View offers a tool library that includes all standard tools of the EMCO PC machines and the EMCO Concept machines.

Assign tool to tool station

- Select the tool station to which the tool should be assigned by means of the direction keys.
- Press  to get from the tool stations to the tool types. At the selected tool station the text becomes red.
- Move to the tool that should be taken over into the tool holder by using the direction keys.
- Press the softkey "TAKE TOOL" or .
- The desired tool will be assigned to the selected tool station.
A possibly already existing tool will be replaced by the new tool.

Remove tool from tool station

- Use the direction keys to move the highlight to the tool station from which the tool should be removed.
- Press the soft key "REMOVE TOOL".

Press  and select "TOOLS".

The left half of the screen shows the tool stations at the machine. Tool stations that are not occupied are marked "--EMPTY--".

The right half of the screen shows the list of available tool types. The lower part of the screen shows the selection boxes for driven tools as well as the tool colour (only for machines with driven tools). Suitable tool types can be defined as driven tool ("DRIVEN TOOL ON/OFF") with axial or radial orientation.

- The tool will be removed and the selected tool station displays "--EMPTY--".
- In this way please enter all tools being necessary for the simulation of the respective CNC-program at the corresponding positions.
- The changes are activated with the  key.
- The new settings become only active after the simulation has been started anew by means of the softkeys "CLEAR SCREEN"+"START".

Changing the tool colour

Every tool is being assigned a characteristic colour that is displayed in the right colour field.

- Select the tool at the tool station by using the direction keys.
- Press the softkey "CHANGE COLOUR". The tool colours can be changed as desired by selecting the RGB-values (red, green, blue) within a range of 0 to 255. The selected colour is displayed in the left colour field.
- To save the new colour, please press the  key.
- To restore the original colour of a tool, please press the softkey "RESET COLOUR".
- You can restore the original colour of all tools by pressing the softkey "STANDARD COLOURS".

Input for Win 3D-View with FANUC 0-TC, FANUC 21 TB and SINUMERIK 810/820 T



Tool selection FANUC 0-TC

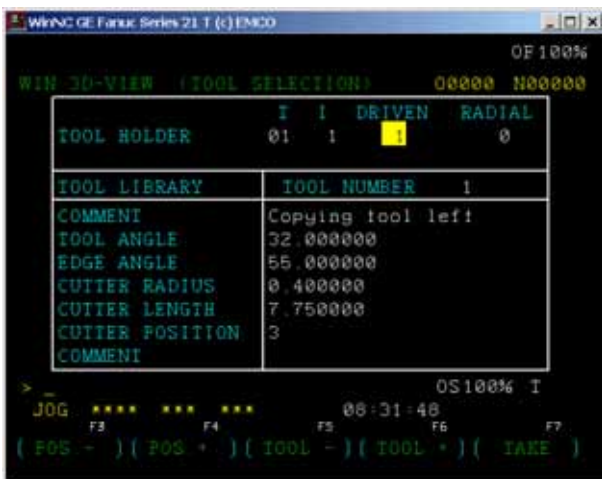

Tool selection FANUC 21 TB



Tool selection SINUMERIK 810/820 T

For the simulation the correct tools have to be assigned to the tool positions. The same applies to the machining process, where the tools have to be clamped in the right position on the tool holder. The Win 3D-View offers a tool library that includes all standard tools of the EMCO PC machines and the EMCO Concept machines.

- Press the softkey "TOOLS", respectively the soft key "TOOL-SELECT" and the input pictures as shown on the opposite page are displayed.
- You can define the tool station in the upper field called "TOOLHOLDER" by means of the softkeys "POS.+" and "POS.-" or the direction keys. Suitable tool types can be defined as driven tools ("DRIVEN"=1) with radial orientation ("RADIAL"=1) or axial orientation ("RADIAL"=0).
- Select the corresponding tool within the box "TOOL LIBRARY" by using the soft keys "TOOL+" and "TOOL-" or the direction keys. The description and data of the selected tool are displayed.
- Press the softkey "TAKE OVER", respectively "TAKE" or the ENTER key to assign the selected tool to the tool station.
- In this way enter all tools being necessary for the simulation of the respective CNC-program in the corresponding positions.

The SINUMERIK 810/820 T stores all tool data under the address D. The two corners of the parting-off tool must be stored in successive D-numbers (e.g. D4 and D5). The first D-number includes the data of the measured corner, the second tool data differ in the tool width.

As soon as you enter a parting-off or a cutting-in tool, an input window appears on the screen, demanding the T0-number (address D) for the measured corner. Enter the T0-number for the measured corner. By pressing ENTER while the input line is empty, you return to the previous screen mask.

Note:

The tool number can be entered directly for the tool holder position, where the cursor stands (e.g. 31 ENTER).



Input for Win 3D-View with SINUMERIK 810D/840D

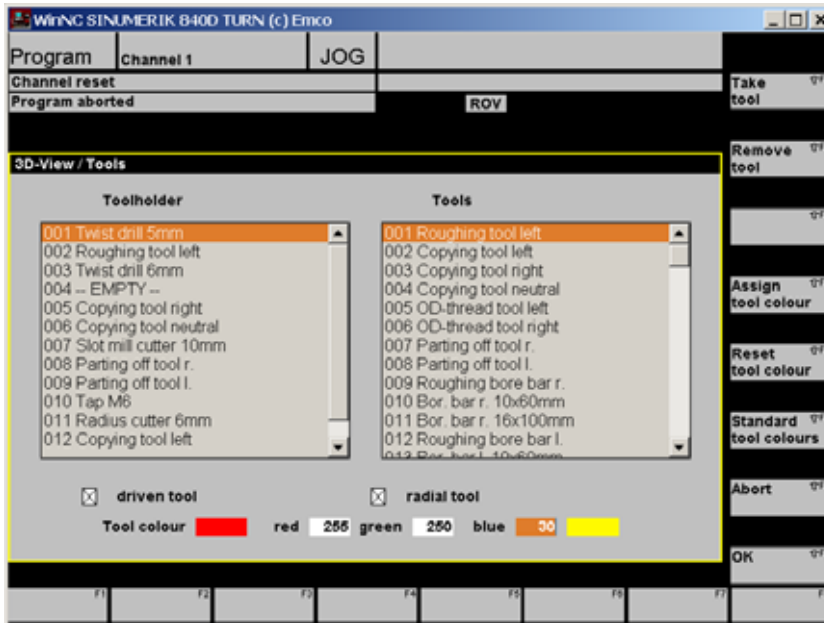

Tool selection SINUMERIK 810D/840D

Press the "Tool" softkey.

The left part of the screen shows the tool stations of the machine. Tool stations that are not occupied are marked "--EMPTY--".

The right part of the screen shows a list of existing tool types.

The lower part of the screen shows the selection fields for driven tools and the tool colour (Only for machines with driven tools.).

Suitable tools can be defined as driven tools with axial or radial adjustment.

For the simulation it is necessary that the correct tools are related to the tool holder position, just as the tools must be clamped in the correct toolholder positions during machining.

Win 3D-View offers a tool library that includes all standard tools of EMCO PC machines and EMCO Concept machines.

Assign tool to tool station

- Click on the tool that should be taken over into the tool holder.
- Click on the tool station to which the selected tool should be assigned.
- Press the "Take tool" softkey.
- The desired tool will be assigned to the selected tool station.
A possibly already existing tool will be replaced by the new one.

Remove tool from tool station

- Click on the tool station from which the tool should be removed.
- Press the "Remove tool" softkey.
- The tool will be removed and the selected tool station displays "--EMPTY--".

- In this way please enter all tools, that are necessary for the simulation of the corresponding CNC-program, at the correct tool positions.
- By pressing the "OK" softkey the changes are activated, by pressing "Abort" the changes will be dropped.
- The new settings will be only activated after the simulation has been started again with the "Start" softkey.

Change of tool colour

Every tool is being assigned a characteristic colour. In order to change a tool colour you have to select the tool at the tool station by using the direction keys:

- Select the tool at the tool station by means of the direction keys.
- Change the tool colours as desired by selecting the RGB-values (red, green, blue) within a range of 0 to 255.
- In order to store the new colour, please press the "Assign tool colour" softkey.
- In order to go back to the original colour of a tool, press the "Reset tool colour" softkey.
- You can restore the original colour of all tools by pressing the softkey "Standard tool colours".



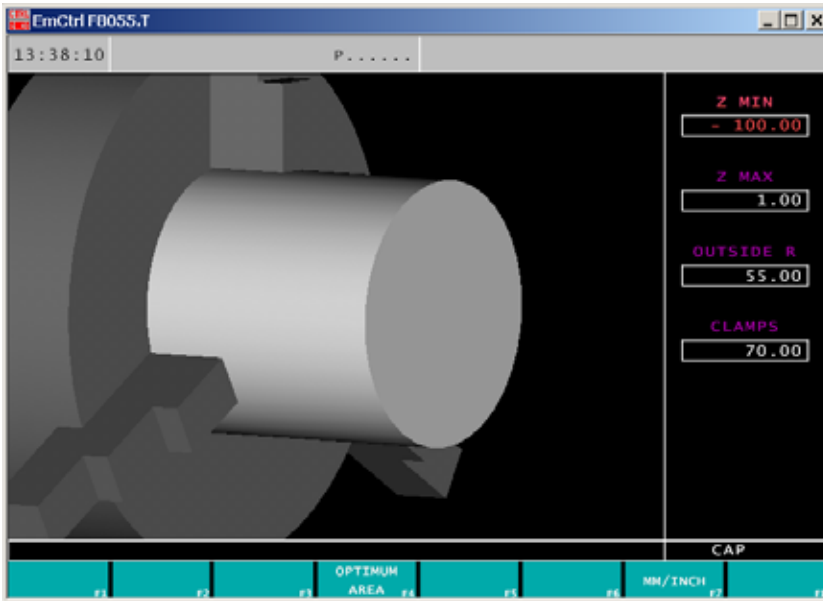

Define Workpiece

Define blank workpiece for FAGOR 8055 TC



Input picture for blank workpiece definition

It is possible to change the size of the display before the simulation starts. The display size can be defined anew by setting new maximum and minimum values for the Z-axis as well as for the workpiece radius. The values are referred to the machine datum.

- Press the softkey "DISPLAY AREA".
- Select the individual fields with the direction keys  and  and enter the corresponding value.
- Confirm the input with . If you wish to leave the mode without any changes, press .

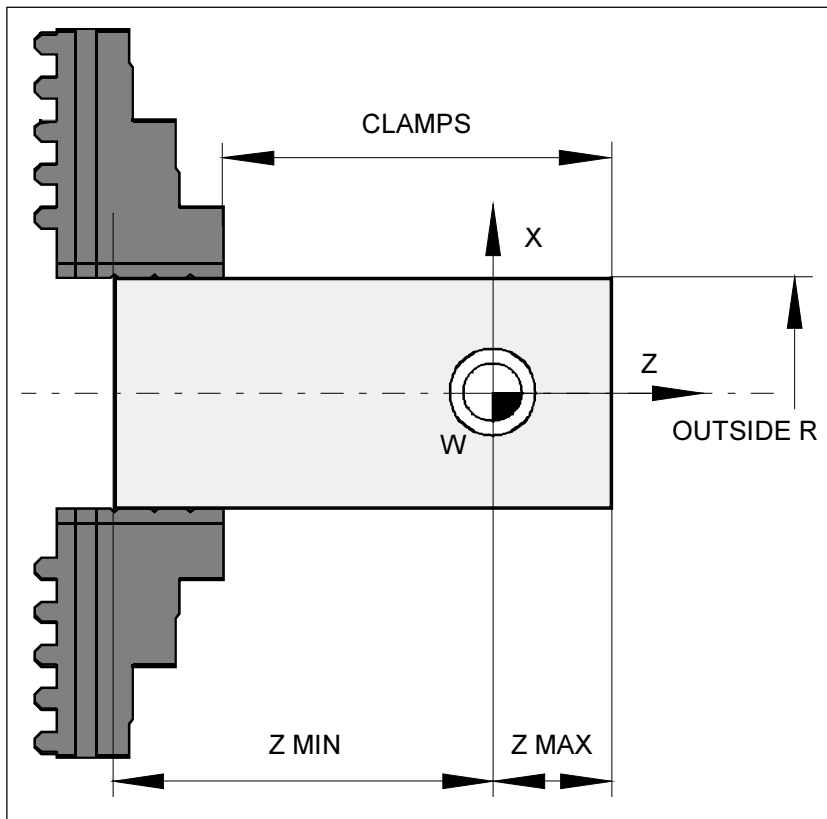

Z MIN
Distance between workpiece datum and rear face of the workpiece.

Z MAX
Distance between workpiece datum and front face of the workpiece.

CLAMPS
Distance between the face of the collets and the front face of the workpiece (protruding length of the blank workpiece from the clamping device).

OUTSIDE R
Radius of the blank workpiece.

Define blank workpiece for FANUC 0-TC, FANUC 21 TB and SINUMERIK 810/820 T

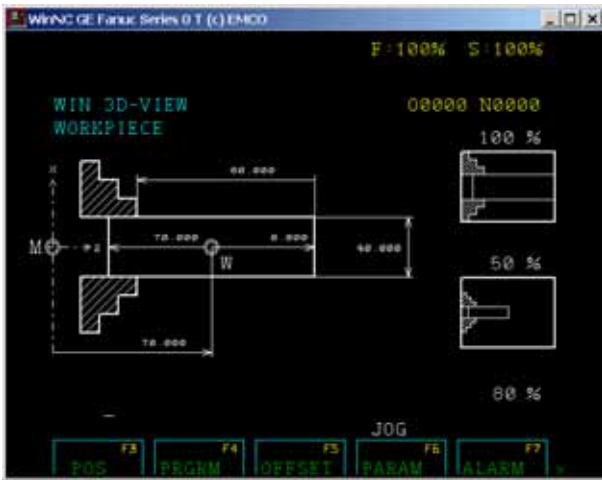

Blank workpiece definition FANUC 0-TC

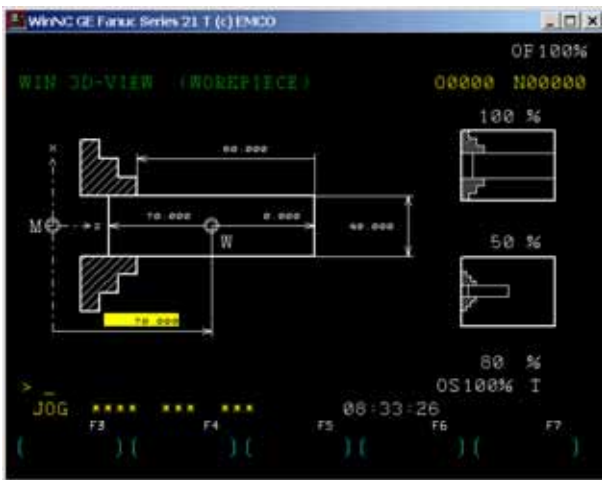

Blank workpiece definition FANUC 21 TB

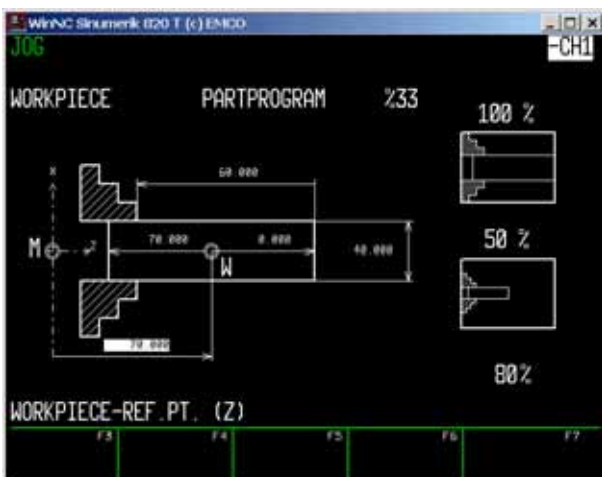

Blank workpiece definition SINUMERIK 810/820 T

- Press the softkey "WORKP.", respectively "WORK-PIECE".
- Use the direction keys to select the individual values.
Below the display of the blank workpieces the SINUMERIK 810/820T displays the meaning of the respective value (e.g. WORKPIECE-REF. PT. (Z)).
- You have to enter the following data:
Position of the workpiece datum in relation to the machine datum M in Z.
Dimension of the blank workpiece in relation to the workpiece datum W in +Z and -Z.
Diameter of the blank workpiece
Protruding length of the blank workpiece from the clamping device in Z.
- The arrows in the input mask indicate the positive direction of the corresponding input value. The individual values can be either positive or negative (except for the diameter) which leads to different situations of the blank workpieces (please refer to examples of blank workpiece definitions).

Note:

The simulation also considers the zero offsets that are called up in the programm with G54 - G59. Therefore, they have to be taken into consideration when defining the positions of the blank workpieces.



Define blank workpiece for SINUMERIK 810D/840D

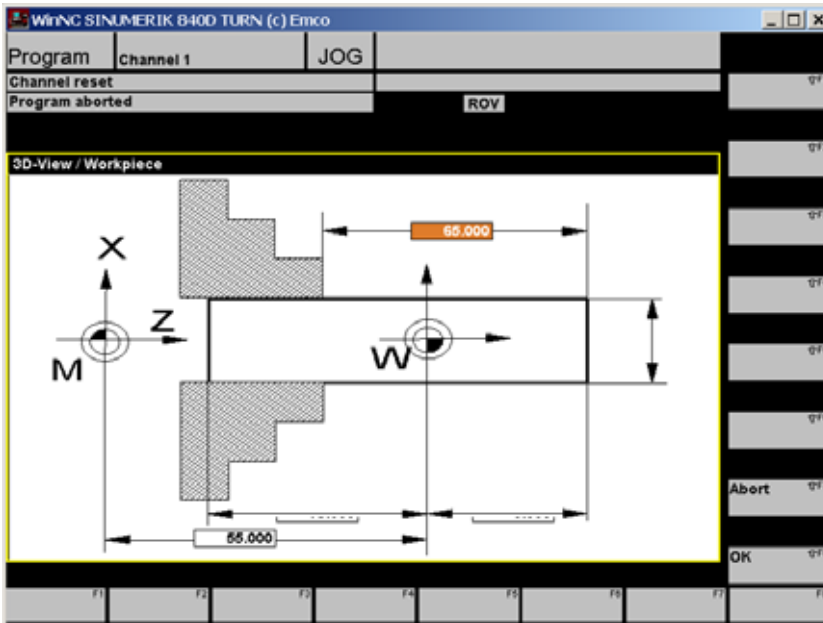

Input picture for blank workpiece definition

- Press the "Workpiece" softkey.
- You may select every single value by using the mouse or the direction keys.
- The following dimensions have to be entered:
 - Position of the workpiece datum** related to the machine datum M in Z.
 - Expansion of the blank workpiece** related to the workpiece datum W in +Z and -Z.
 - Diameter of the blank workpiece**
 - Projecting length of the blank workpiece** from the clamping device in Z.
- The axis arrows in the input picture indicate the positive direction for the respective entry value. The single values can be either positive or negative (except diameter), which leads to different workpiece situations (see examples).
- Confirm the entry with "OK".

Note:

The simulation also considers the zero offsets that are called up in the program by G54 - G59. Therefore, it is not necessary to define the position of the workpiece datum (standard value 0).



Examples for Workpiece Definition

Entry at the screen

Real clamping situation and illustration

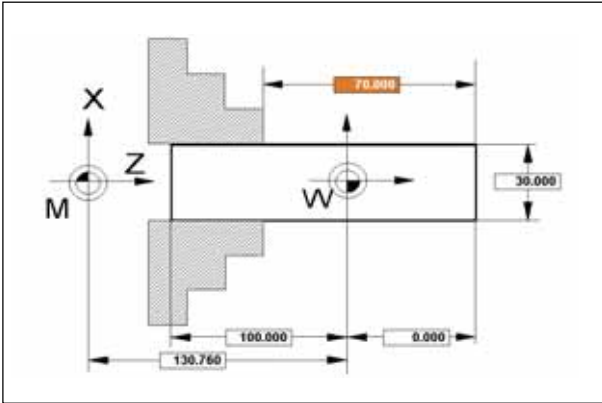

The workpiece dimension from the workpiece datum W to the right is zero.

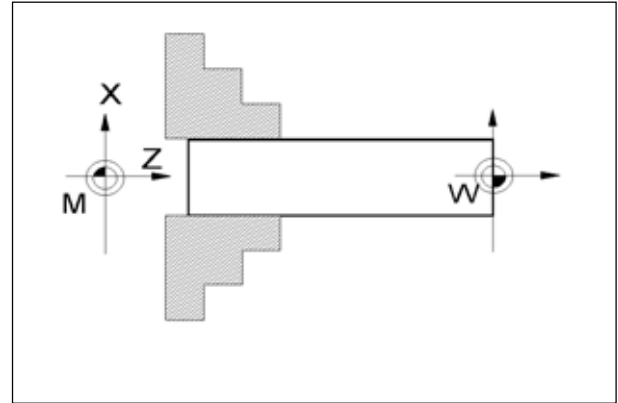

The workpiece datum W lies on the right front end of the workpiece.

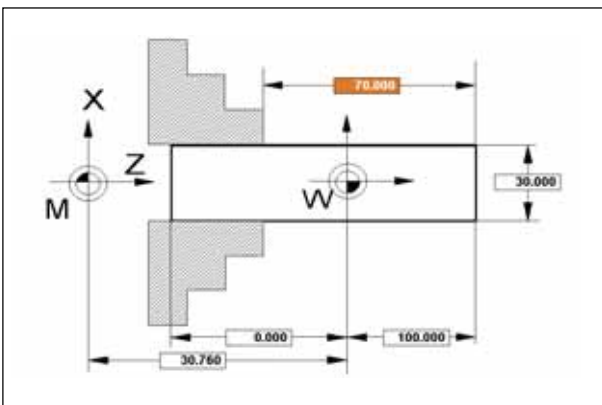

The workpiece dimension from the workpiece datum W to the left is zero.

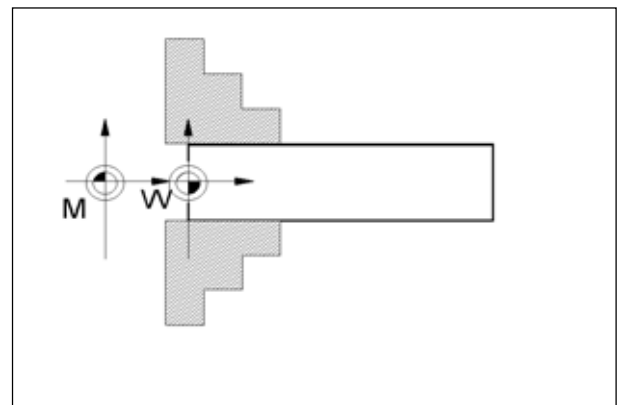

The workpiece datum W lies on the left front end of the workpiece (within the chuck).

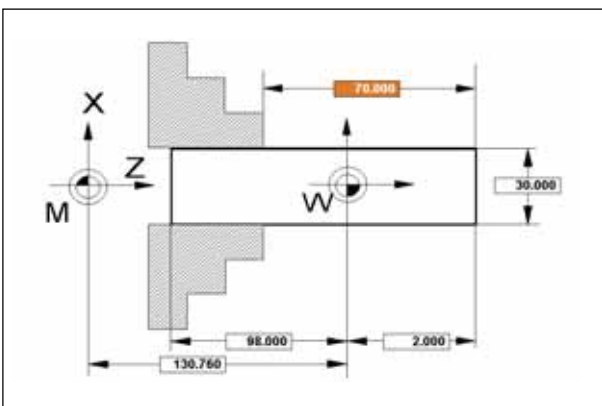

The workpiece dimension from the workpiece datum W to the right is 2 mm.

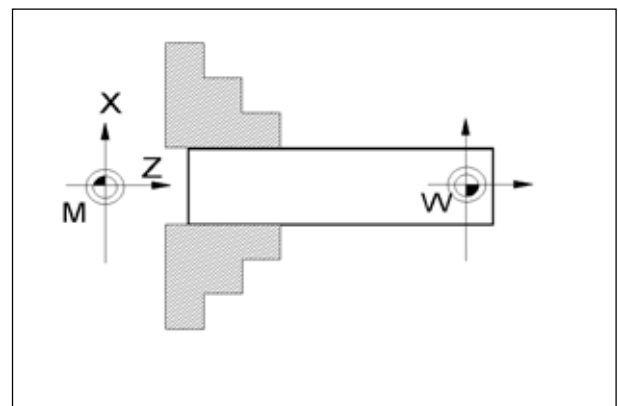

The workpiece datum W lies 2 mm within the right front end of the workpiece (practical reason: Facing the front end up to the workpiece datum W).

Simulation

Simulation sequence for Win 3D-View with FAGOR 8055 TC

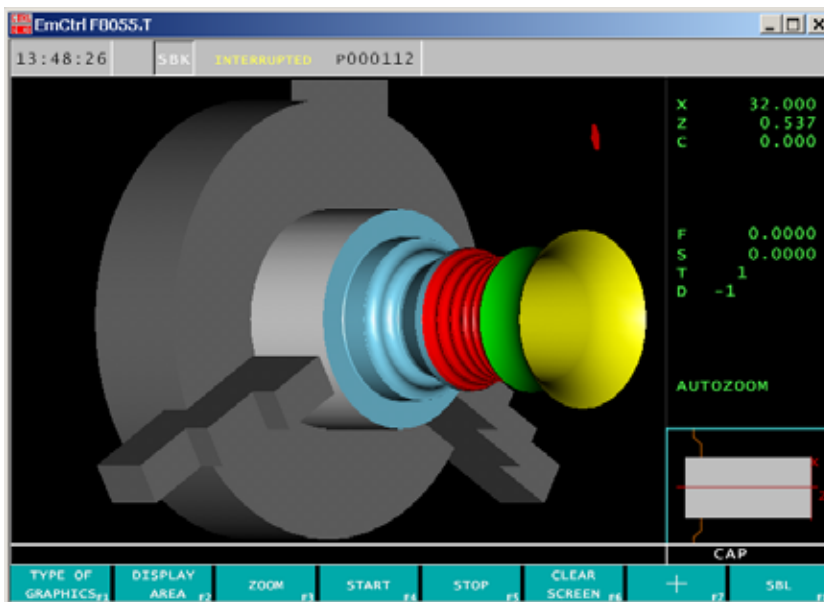

Simulation window FAGOR 8055 TC

After having called the simulation, the menu appears.

The rectangle in the opposite illustration is the simulation window.

In the simulation window the machining of the workpiece is shown.

In addition to the simulation window the current feeds, spindle speeds, names and position values of the tool as well as the current cycle are displayed. Error messages also appear here. E.g. danger of collision.

Softkey "START"

The simulation is started with "START". Before being able to start the simulation, a CNC program must have been selected.

Softkey "STOP"

The simulation is interrupted with "STOP". To continue the simulation, press the softkey "START".

Softkey "SBL"

The softkey "SBL" enables to stop the simulation after every block. The simulation can be continued by pressing the soft key "START".

Softkey "CLEAR SCREEN"

With "CLEAR SCREEN" both the simulation and the CNC program return to their starting position (first program block).

Display mode, section view

The softkey "3D-VIEW PARAMETER" (see Basic Settings) enables the setting of the display mode.

Rotate picture, zoom, shift

The simulation window can be rotated as desired within one plane and at any time by pressing and holding the left mouse key. For movements around

the Z-axis you have to press  + left mouse key + mouse movement to the right or to the left.

The simulation window can be enlarged or reduced by means of the softkeys "ZOOM+" and "ZOOM-" or

by means of  + left mouse key + upward or downward mouse movement.

The direction keys enable to shift the simulation window.

Press the right mouse button + mouse movement in the required direction to shift the simulation image in an infinitely variable way.

The original line of vision is restored with the softkey "RESET LINE OF VISION".

Simulation sequence for Win 3D-View with FANUC 0-TC, FANUC 21 TB and SINUMERIK 810/820 T

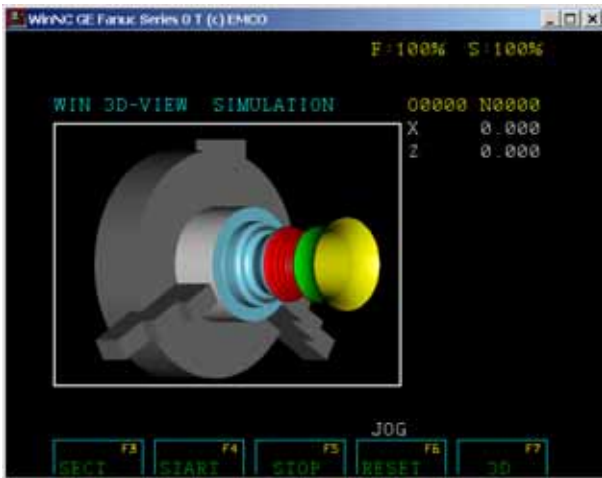

Simulation window FANUC 0-TC

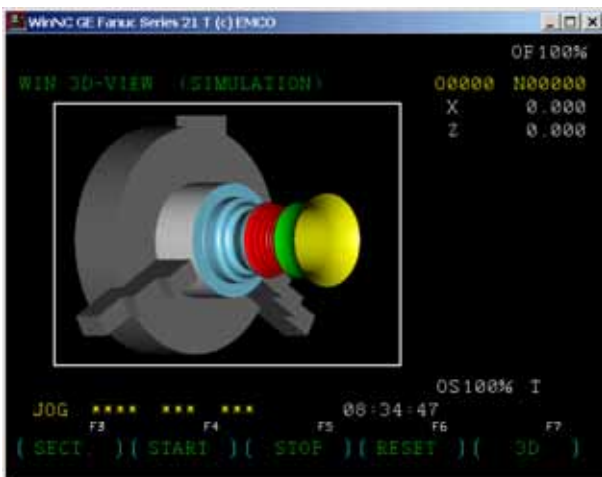

Simulation window FANUC 21 TB

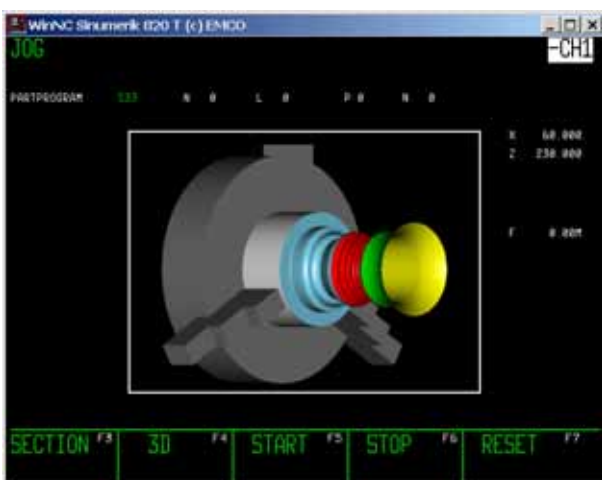

Simulation window SINUMERIK 810/820 T

- Press the softkey "SIMULATION" , respectively "SIMUL."

The rectangle in the picture is the simulation window. In the simulation window the machining of the workpiece is shown.

In addition to the simulation window the current position values of the tool and the current program block are displayed.

The WinNC SINUMERIK 810/820 T additionally shows the current subprogram and the feed.

The following softkeys are at your disposal:

"SECTION", "START", "STOP" and "RESET".

The function of the softkeys "BLOCK SEARCH" and "PROGRAM CONTROL" is the same as for WinNC without 3D-View.

Softkey "START"

The simulation is started with "START". Before being able to start the simulation, a CNC program must have been selected.

Softkey "STOP"

The simulation is interrupted with "STOP". To continue the simulation, press the softkey "START".

Softkey "RESET"

With "RESET" both the simulation and the CNC program return to their starting position (first program block).

Rotate picture, zoom, shift

The simulation window can be rotated as desired within one plane and at any time by pressing and holding the left mouse key. For movements around

the Z-axis you have to press  + left mouse key + mouse movement to the right or to the left.

The simulation window can be enlarged or reduced by means of the softkeys "ZOOM+" and "ZOOM-" or

by means of  + left mouse key + upward or downward mouse movement.

The direction keys enable to shift the simulation window.

Press the right mouse button + mouse movement in the required direction to shift the simulation image in an infinitely variable way.

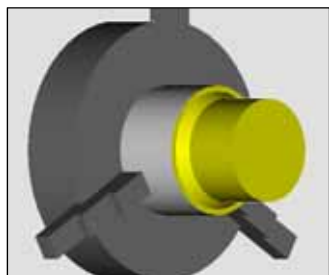

"OFF"

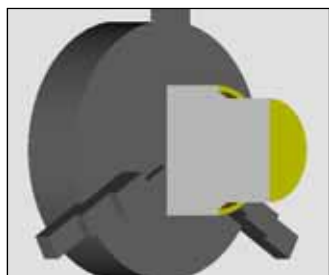

"FULL-SECTION"

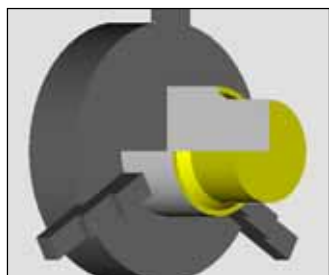

"HALF-SECTION"

Softkey "SECTION"

The section view enables to observe normally hidden sequences. With "SECTION" you can select a section view before the simulation starts.

- Press the softkey "SECTION".
- Select the section view with "HALF-SECTION" or "FULL-SECTION".
- The section view is terminated with "OFF". The section view remains active until it is deselected with "OFF".

In case the section view is changed during the simulation it becomes only active after having pressed "RESET" and "START".

Simulation sequence for Win 3D-View with SINUMERIK 810D/840D

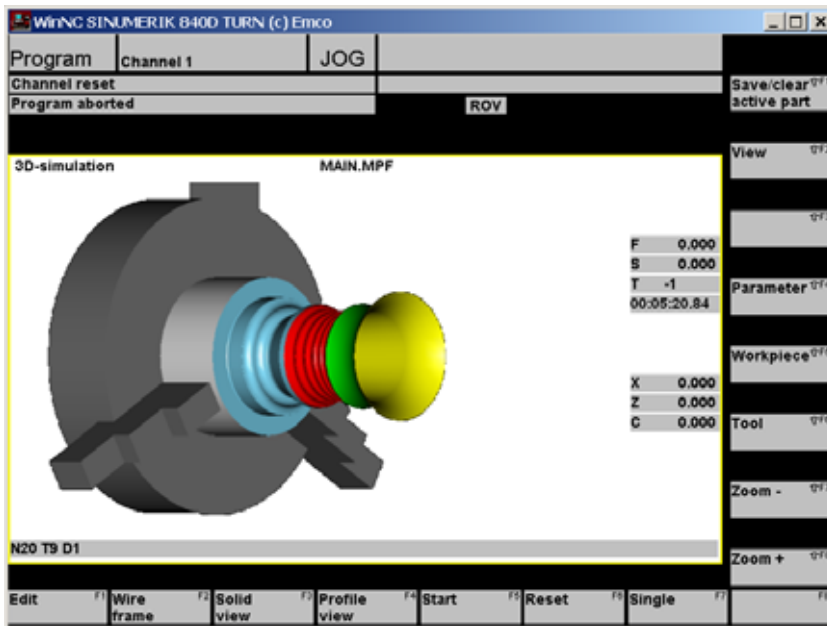

Simulation window SINUMERIK 810D/840D

Press the "3D-View" softkey.

The rectangle in the picture on the left is the simulation window. The machining of the workpiece is shown in the simulation window.

In addition to the simulation window the actual feeds, spindle speeds, names and positions of the tool, machining time as well as the current program block are displayed.

Error messages also appear here, e.g. danger of collision.

Softkey "Start"

With "Start" the simulation is started. Before being able to start a simulation, a CNC program must have been selected. The name of the actual CNC program is displayed in the upper center of the simulation window, e.g. MAIN.MPF.

Softkey "Single"

With the "Single" softkey the simulation is stopped after every block. The simulation can be continued by pressing the "Start" softkey.

Softkey "Reset"

With "Reset" both the simulation and the CNC program are set back to the initial status (first program block).

Display mode, Section view

The softkey "View" enables the setting of the display mode and of the section view (see Basic Settings). After having finished the simulation it is possible to change the display mode by means of the softkeys "Wire frame", "Solid view" and "Profile view".

During a simulation run the display mode can only be changed by pressing "Single" before and after the new selection.

Rotate picture, Zoom, Shift

The simulation picture can be rotated as desired within one plane and at any time by pressing and holding the left mouse key. For movements around

the Z-axis you have to press  + left mouse key + mouse movement to the right or to the left.

The simulation window can be enlarged or reduced by means of the softkeys "Zoom+" and "Zoom-" or by means of  + left mouse key + upward or downward mouse movement.

The direction keys enable to shift the simulation window.

Press the right mouse button + mouse movement in the required direction to shift the simulation image in an infinitely variable way.

Save active part

The "Save/clear active part" softkey saves the currently machined workpiece. It can be used again after "Reset" during a new start. The selection can be cancelled by pressing the softkey again.



Tool modelling with the 3D-Tool Generator

With the 3D-ToolGenerator you can modify existing tools and create new tools.

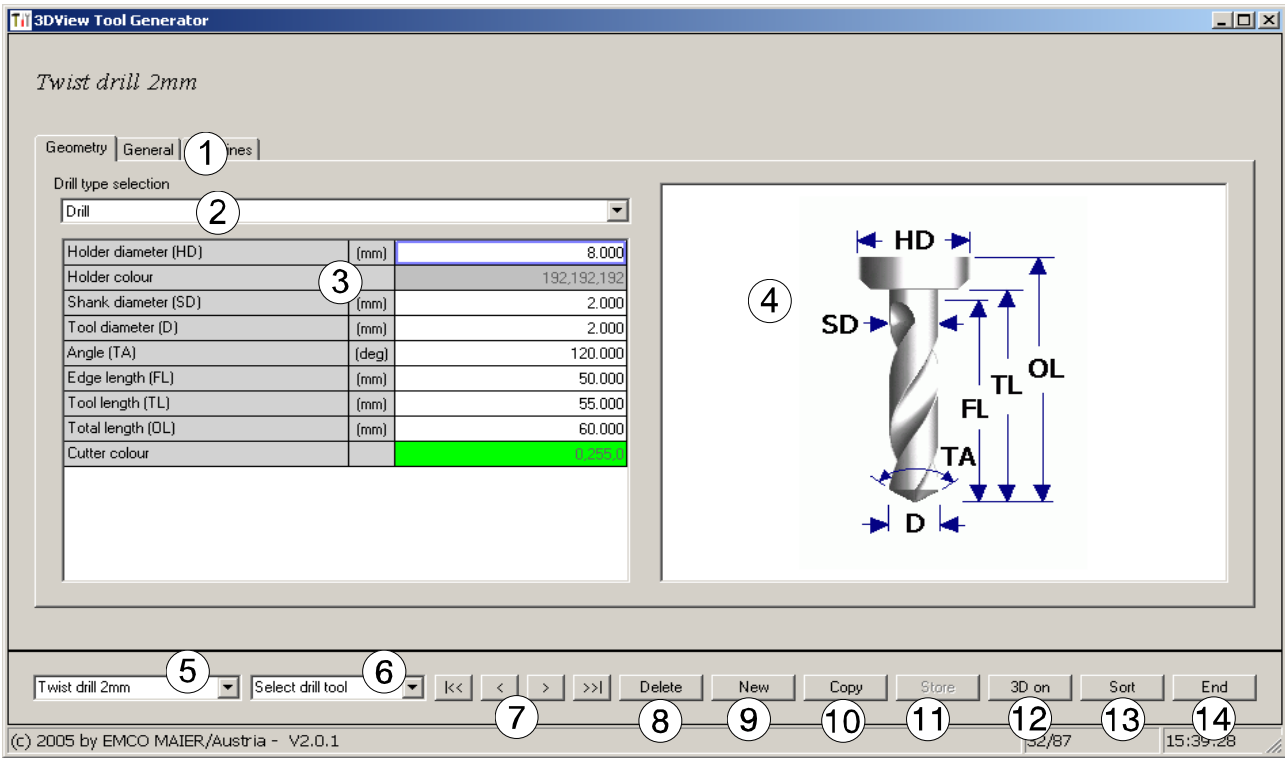

- 1 Register cards for "Geometry", "General" and "Machines" for drilling and milling tools and "Tip", "Holder", "General" and "Machines" for turning tools.
- 2 Selection of tool types
- 3 This window enables the input of tool dimensions.
- 4 Graphical support for the tool dimensioning
- 5 Choice of tools for the selected tool type
- 6 Choice of tool types (here: only drill) "Turning tool", "Milling tool" and "Drilling tool" reduce the tool choice to the respective type (here: only drilling tools are listed). "All" does not reduce the tool choice.
- 7 Buttons for quickly browsing through the tools

- go to first tool in the group
- go to last tool in the group
- go forward in the list by one tool
- go back in the list by one tool

- 8 Button to delete tools
- 9 Button to create new tools
- 10 Button to copy tools
- 11 Button to save changes
- 12 Button for 3D visualization
- 13 Button to sort tools
- 14 Button to terminate the 3DView tool generator

Generating a new tool

- Set the selection for tool types to "Selection all".
- Press the button to generate new tools.
- Select the tool name, the tool type and the measurement system.

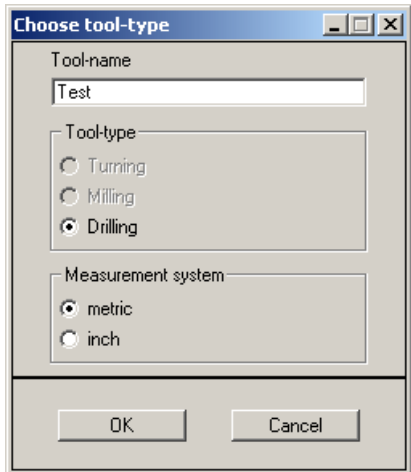

- Confirm the entries with "OK".

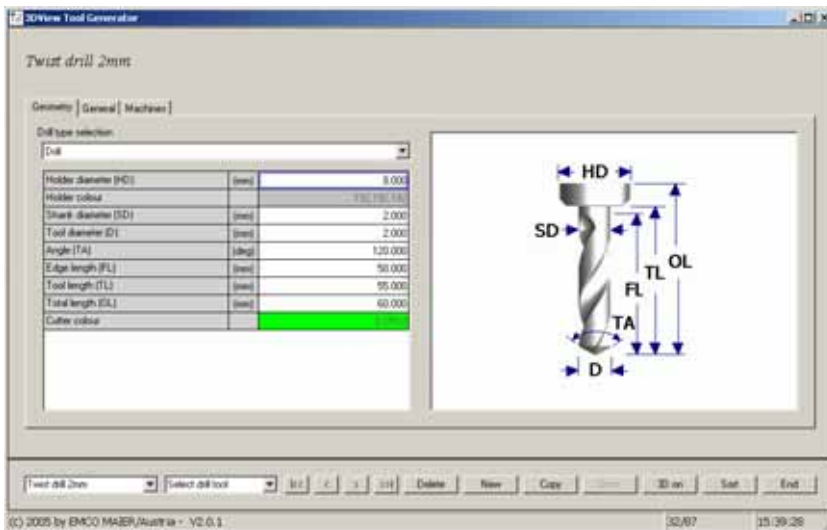

- Confirm the entries with "Store".

Copying a tool

- Call the tool you wish to copy.
- Press the button to copy tools.
- Enter the new tool name.
- Confirm the inputs with "Save".

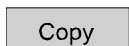

Changing an existing tool

- Call the tool you wish to change.
- Change the values.
- Confirm the entries with "Store".



Selecting a tool colour

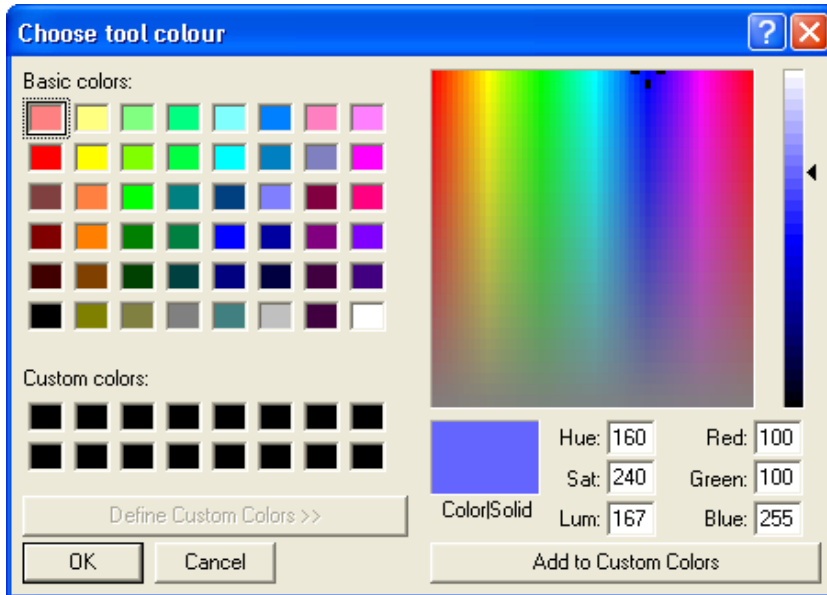

- Make a double click with the mouse pointer in the coloured box of the tool colour. The window "Select tool colour" will appear.
- Select the required colour.



- Confirm the entries with "OK".

Visualizing a tool

- Press the button for 3D visualization.

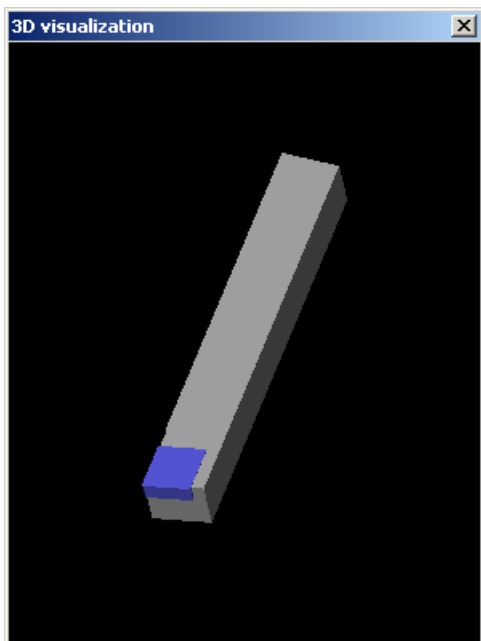
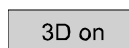

Rotating image

At any time you can rotate the simulation image in one plane as required by pressing and holding the left mouse button. For movements around the Z axis

press + left mouse button + mouse movement to the right or to the left.

Zooming

You can zoom the tool simulation image in or out by means of + left mouse button + mouse movement upwards or downwards

Shifting

Press the right mouse button + mouse movement in the required direction to shift the simulation image.

Sorting function

The sorting sequence makes it possible to display the tools being sorted according to tool types.

Every time the sorting sequence is changed, the selection for tools will be updated.

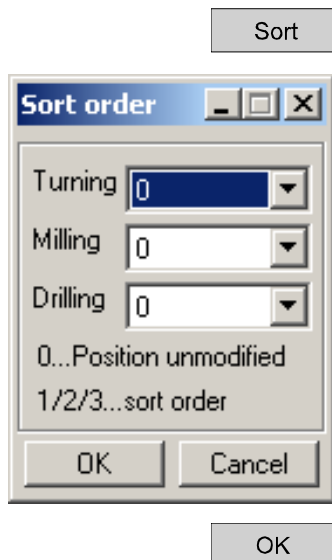

- Press the button for sorting.
- Define new sorting sequence.
- Confirm the entries with "OK".